

BMS Series

DC Brushless Torque Motors

Slotless, brushless stator design provides zero-cogging torque for unsurpassed velocity control

Smoother velocity than with standard DC brush-type motors with the advantage of reliable brushless technology

Standard NEMA frame sizes

Ultra-high resolution capability with amplified sine-wave encoder and multiplier

Follows the 2011/65/EU RoHS 2 Directive

Aerotech's BMS series brushless, slotless servomotors represent the ultimate in high-performance rotary motors. Available in standard NEMA frame sizes, these motors utilize a slotless rotor design for superior velocity smoothness and control.

Featuring rare-earth magnets and a high pole-count rotor, the BMS series provides maximum torque and acceleration in a small package. Custom mechanical or electrical variations of the BMS can be engineered with minimal lead time.

Smoother than DC Motors

The BMS series motors can replace standard brushless or brush-type motors when superior velocity smoothness and control are required. DC brush-type motors have been popular in applications such as machine tool and scanning because of their smooth low-speed control. The BMS motors provide superior smoothness and have higher acceleration capability than a DC brush motor. Higher acceleration results in higher machine throughput and performance.

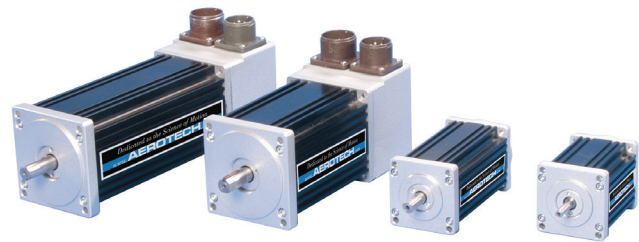

High Performance Design

The BMS series is unlike conventional brushless servomotors because it incorporates a totally slotless stator design that provides the ultimate in smooth velocity control. These motors are designed for applications requiring superior torque and stability performance. The unique design of the BMS series motors provides a closer inertia match with mechanical systems than comparable models. This means better stability and easier tuning.

Ultra-High Encoder Resolution

The BMS series motors can be equipped with a variety of encoder resolution options for any application. In addition to the standard RS-422 line driver output, an optional amplified sine-wave encoder can be used to provide ultra-high resolution. Aerotech offers encoder multipliers as an option for drives connected to the A3200 system, as well as external multiplier boxes. Resolutions as high as 1,000,000 counts per revolution are achievable.

BMS Series SPECIFICATIONS

Model		BMS35	BMS60	BMS100	BMS280	BMS465
Winding Designation		-A	-A	-A	-A	-A
Performance Specifications^(1, 5)						
Stall Torque, Continuous ⁽²⁾	N·m	0.27	0.33	0.56	1.60	2.86
	oz·in	38.0	46.2	80.0	227.0	404.8
Peak Torque ⁽³⁾	N·m	1.07	1.31	2.26	6.41	11.43
	oz·in	152.0	184.9	320.0	908.0	1619.2
Rated Speed	rpm	4,000	4,000	3,000	3,000	2,000
Rated Power Output, Continuous	watts	96.0	112	133	381	457
Electrical Specifications⁽⁵⁾						
BEMF Constant (line to line, max)	Volts _{pk} /krpm	12.9	19	40	57	79
Continuous Current, Stall ⁽²⁾	Amp _{pk}	2.5	2.3	2.1	3.8	4.9
	Amp _{rms}	1.7	1.6	1.5	2.7	3.5
Peak Current, Stall ⁽³⁾	Amp _{pk}	9.8	9.2	8.4	15.2	19.6
	Amp _{rms}	6.9	6.5	5.9	10.7	13.9
Torque Constant ^(4,8)	N·m /Amp _{pk}	0.11	0.14	0.27	0.42	0.58
	oz·in /Amp _{pk}	15.5	20.1	38.1	59.7	82.6
	N·m /Amp _{rms}	0.15	0.20	0.38	0.60	0.82
	oz·in /Amp _{rms}	21.9	28.4	53.9	84.5	116.8
Motor Constant ^(2,4)	N·m/√W	0.046	0.050	0.076	0.179	0.280
	oz·m/√W	6.52	7.02	10.74	25.34	39.70
Resistance, 25°C (line to line)	ohms	5.8	8.4	12.9	5.7	4.4
Inductance (line to line)	mH	1.7	1.30	2.40	1.10	0.87
Maximum Bus Voltage	VDC	340	340	340	340	340
Thermal Resistance	C/W	2.21	1.73	1.35	0.93	0.72
Number of Poles	P	8	8	8	14	14
Mechanical Specifications						
Frame Size	NEMA	17	23	23	34	34
Motor Weight	kg	0.6	1.1	1.5	3.60	5.00
	lb	1.3	2.4	3.3	7.9	11.0
Rotor Moment of Inertia	kg·m ²	1.96x10 ⁻⁵	1.96x10 ⁻⁵	3.71x10 ⁻⁵	4.66x10 ⁻⁴	9.28x10 ⁻⁴
	oz·in·s ²	0.0028	0.0028	0.0053	0.0660	0.1314
Max. Radial Load	N	45	89	89	178	178
	lb	10	20	20	40	40
Max. Axial Load	N	45	89	89	89	89
	lb	10	20	20	20	20
Standards		2011/65/EU RoHS 2 Directive				

Notes:

- Performance is dependent upon heat sink configuration, system cooling conditions, and ambient temperature.
- Values shown @ 75°C rise above a 25°C ambient temperature, with housed motor mounted to a 250 mm x 250 mm x 6 mm aluminum heat sink.
- Peak torque assumes correct rms current; consult Aerotech.
- Torque constant and motor constant specified at stall.
- All performance and electrical specifications ±10%.
- Maximum winding temperature is 100°C; thermistor trips at 100°C.
- Ambient operating temperature range 0°C - 25°C. Consult Aerotech for performance in elevated ambient temperatures.
- All Aerotech amplifiers are rated A_{pk}; use torque constant in N·m/A_{pk} when sizing.

BMS Series PERFORMANCE

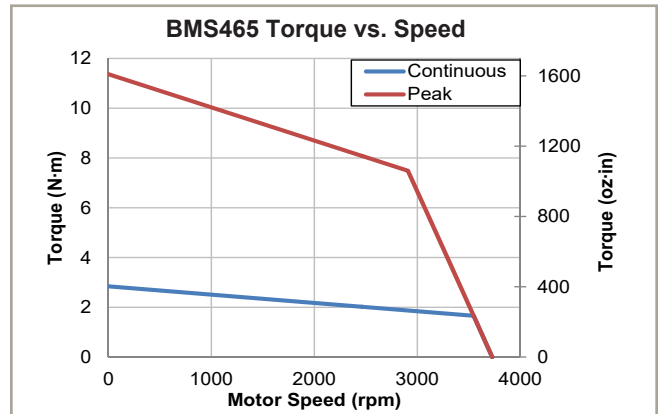
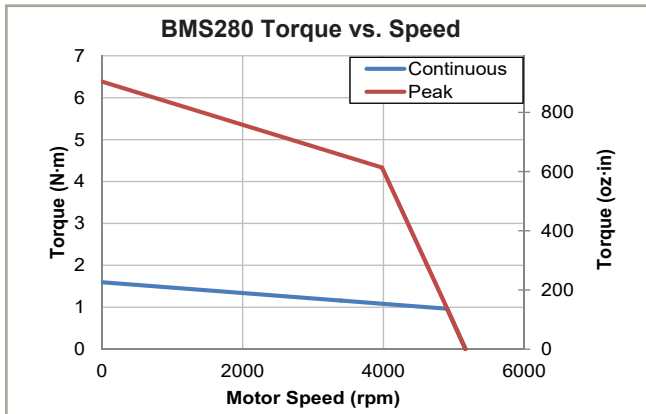
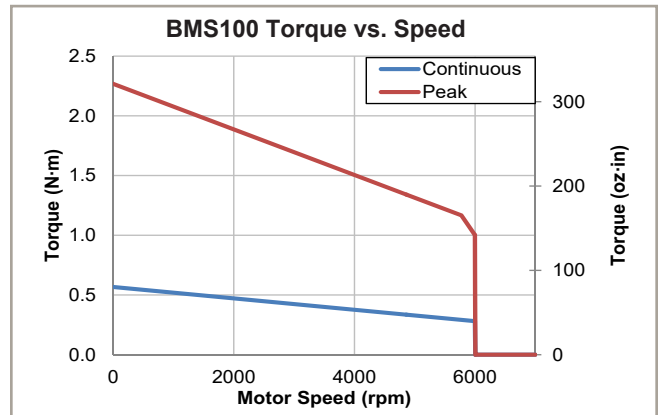
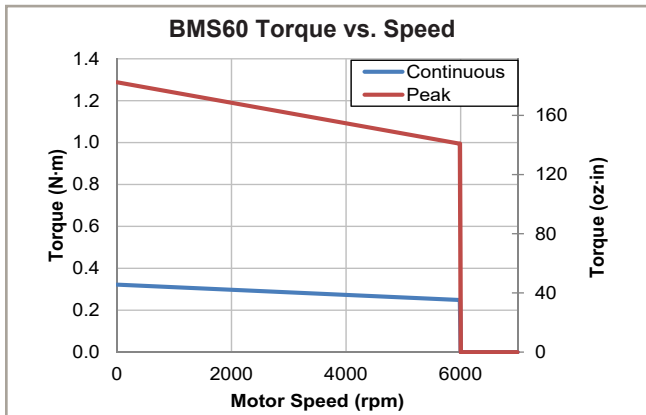
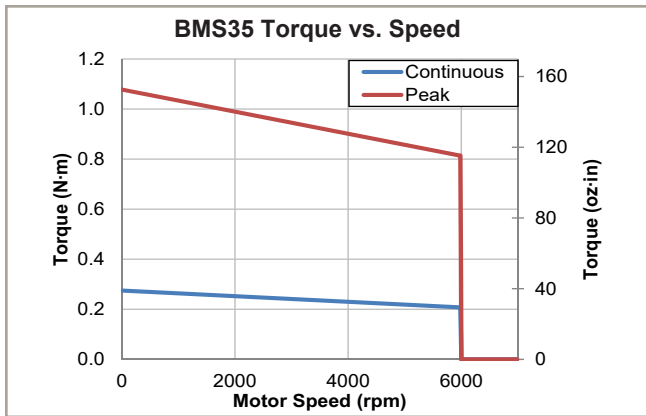

BMS Series DIMENSIONS

**NEMA 17
[BMS35]**

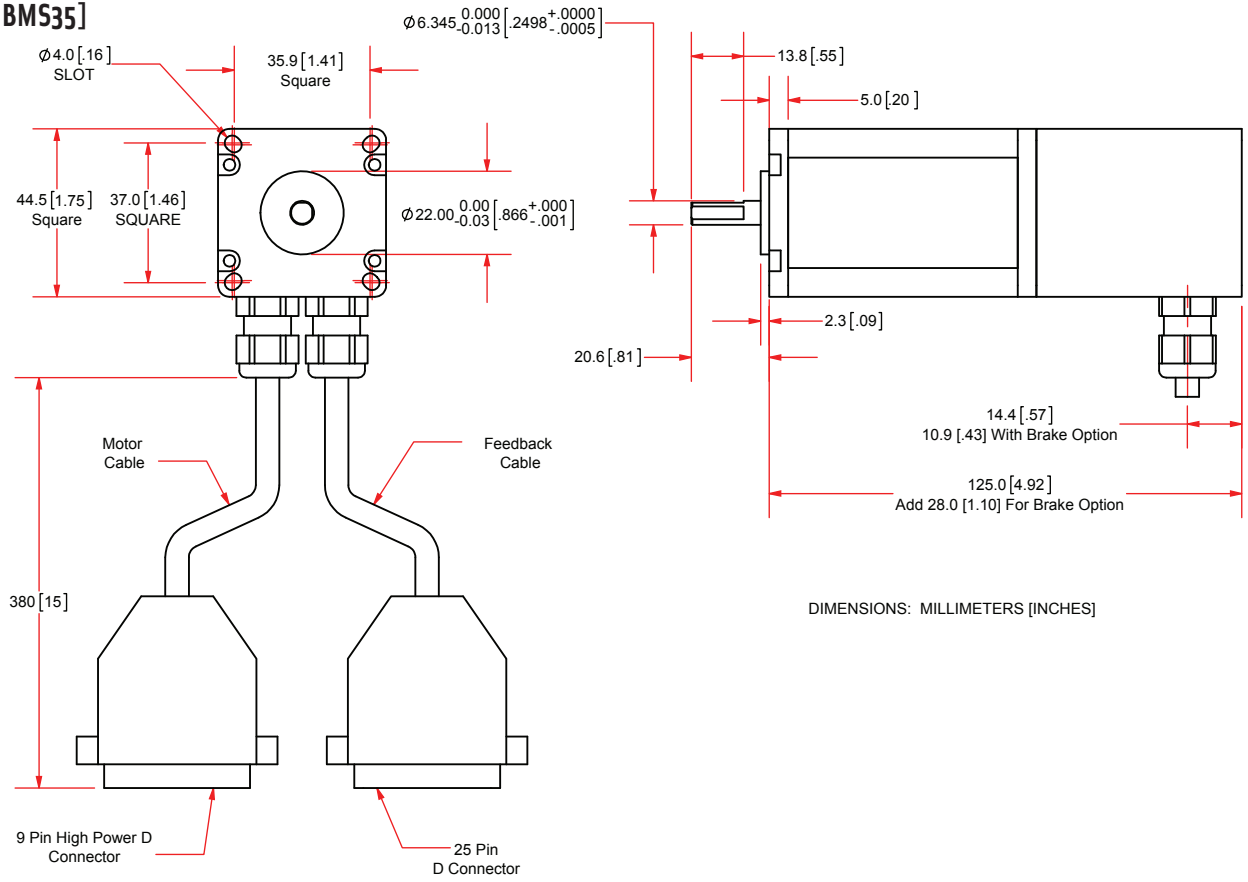

BMS Series DIMENSIONS

NEMA 23 [BMS60, BMS100]

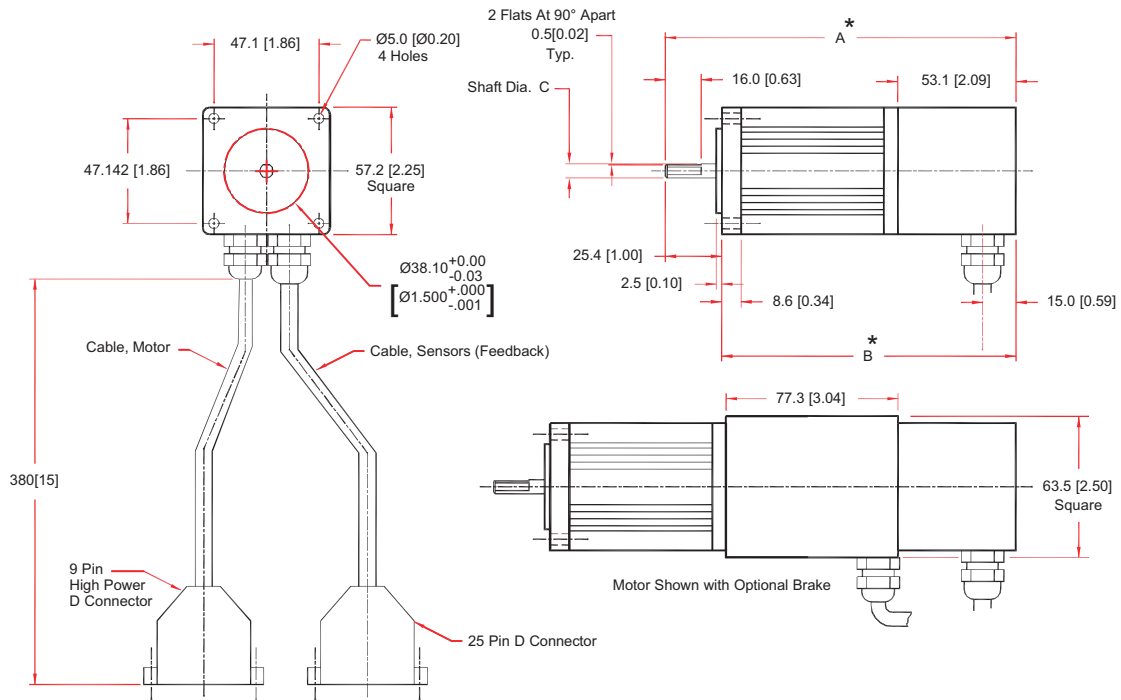

Dimensions - millimeters [inches]

Motor Model No.	A*	B*	C
BMS60	$\frac{157.5}{6.20}$	$\frac{132.1}{5.20}$	$\varnothing 6.345$ +0.000, -0.013 0.2498" +0.0000", -0.0005"
BMS100	$\frac{187.9}{7.40}$	$\frac{162.6}{6.40}$	$\varnothing 9.517$ +0.000, -0.013 0.3747" +0.0000", -0.0005"

* Add 77.3 [3.04 IN.] To Length For Optional Brake.

Note: Additional motor sizes available. Please consult factory and website for latest information

NEMA 34 [BMS280, BMS465]

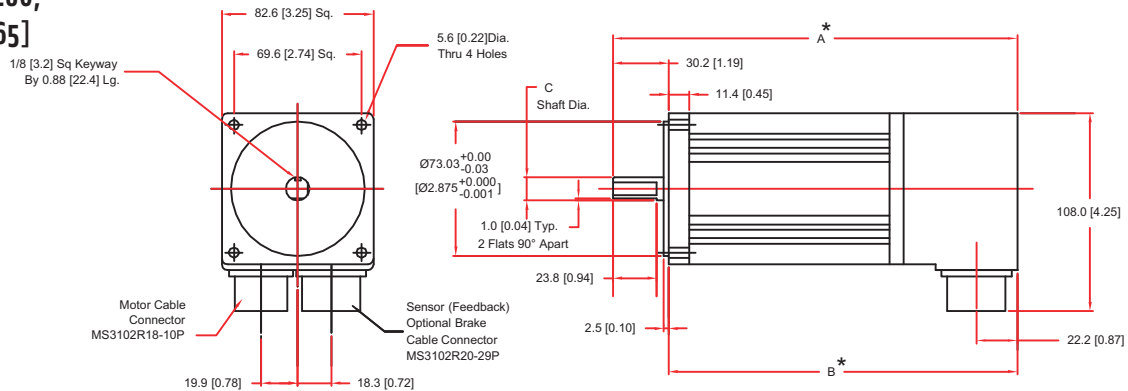

Dimensions - millimeters [inches]

Motor Model No.	A*	B*	C
BMS280	$\frac{220.3}{8.67}$	$\frac{190.0}{7.48}$	$\varnothing 12.69$ +0.000, -0.013 0.4997" +0.0000", -0.0005"
BMS465	$\frac{275.1}{10.83}$	$\frac{244.9}{9.64}$	$\varnothing 12.69$ +0.000, -0.013 0.4997" +0.0000", -0.0005"

* Add 55.6 [2.19 IN.] To Length For Optional Brake.

BMS Series ORDERING INFORMATION

NEMA Brushless Slotless Rotary Servomotor

BMS35	NEMA17 Brushless slotless rotary servomotor
BMS60	NEMA23 Brushless slotless rotary servomotor
BMS100	NEMA23 Brushless slotless rotary servomotor
BMS280	NEMA34 Brushless slotless rotary servomotor
BMS465	NEMA34 Brushless slotless rotary servomotor

Motor Winding (Required)

-A	Motor winding
-B	Motor winding; not available for BMS35

Connectors (Required)

-MS	Integral cable w/MS connector for Fbk and Mtr (-MS); not available for BMS35
-D25	Integral cable w/D25 Fbk and 4D Mtr (-D25); not available for BMS280 or BMS465
-D25-9D	Integral cable w/D25 Fbk, 4D Mtr, and 9D Limit (-D25-9D); not available for BMS280 or BMS465
-D25-FLB	Integral cable w/D25 Fbk, Fly Leads for Mtr, and 9D Limit (-D25-FLB); not available for BMS280 or BMS465
-D25-5DU	Integral cable w/D25 Fbk, 5D Mtr, and 9D Limit (-D25-5DU); not available for BMS280 or BMS465
-D25-9D-CMS	Integral cable w/D25 Fbk, 4D Mtr, and 9D Limit - CMS only (-D25-9D-CMS); not available for BMS280 or BMS465
-D25-4TS	Integral cable w/D25 Fbk, 4TS Mtr, and 9D Limit (-D25-4TS); not available for BMS280 or BMS465

Feedback (Required)

-E1000H	1000 lines/rev TTL incremental encoder w/Hall tracks
-E2000H	2000 lines/rev TTL incremental encoder w/Hall tracks
-E2500H	2500 lines/rev TTL incremental encoder w/Hall tracks; not available for BMS35
-E5000H	5000 lines/rev TTL incremental encoder w/Hall tracks
-E1000ASH	1000 lines/rev 1 V _{pp} incremental encoder w/Hall tracks

Brake (Optional)

-BK	Holding brake (-BK)
-----	---------------------

Cable Type (Optional)

-HF	High flex cable; not available for BMS280 or BMS465
-----	---

Cable Length (dm) (Optional)

-xx	Cable length in decimeters (3.8 dm is default)
-----	--

Note: Not available for BMS280 or BMS465.

Vacuum Preparation (Optional)

-VAC6	Vacuum preparation to 10 ⁻⁶ Torr
-------	---

Accessories (Optional)

MC-HPD25-M	Connector; HPD motor power mate
MC-DB25-F	Connector; DB25 motor feedback mate
MCM-3	Connector; MS motor power mate
MCF-3	Connector; MS motor feedback mate

Note: Accessories are ordered as separate line items.