

BM Series

Brushless Rotary Servomotors

Standard NEMA frame sizes

Neodymium iron boron rare-earth magnets maximize performance

Skewed stator with multi-pole design minimizes torque ripple and cogging for smooth velocity control over a greater speed range

Optional IP65-level construction allows use in harsh environments

Optional brake, front shaft seal, and precision gear reducers

Follows the 2011/65/EU RoHS 2 Directive



High-Performance Design

The BM series consists of Aerotech's high-performance brushless rotary servomotors. The motors feature rare earth magnets for maximum torque and acceleration in a small package. A skewed stator design provides low torque ripple and smooth velocity. Unlike DC brush-type servomotors, the BM series are brushless and maintenance free. This makes them ideal for critical applications where downtime cannot be tolerated.

In addition, the BM series motors have very high power density resulting in high torque in a compact package. Optional IP65 sealing make these motors ideal for harsh environments such as machine tool.

Wide Torque Range

The BM motor series covers a wide range of torque and package sizes. Continuous output torque ranges from 0.16 N·m (22.5 oz·in) to 31.6 N·m (280 lb·in), with peak torques to 94.9 N·m (840 lb·in). Standard frame sizes include NEMA 17, 23, 34, 42 and 56. This makes it easy to mount any motor to Aerotech's gearbox line with no adapter plates. These motors are well-suited to general purpose and high-end servo applications.

Application Flexibility

The standard motor has a 1000-line encoder (4000-line count after quadrature), RS-422 line driver output with Hall effect device outputs for commutation, and MS connectors. Options include increased encoder resolution, sealing for IP65 level protection, brakes, and gearboxes. Standard models can be delivered from stock and custom variations can be engineered to your requirements with minimal lead time.

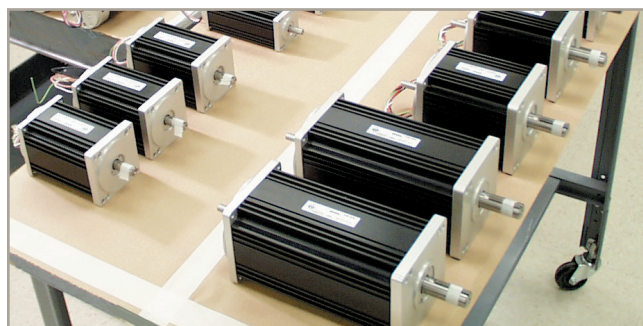

All Aerotech motors are manufactured following ISO9001 standards.

BM Series SPECIFICATIONS

Model		BM22	BM75	BM130	BM200
Performance Specifications^(1,2)					
Stall Torque, Continuous ⁽³⁾	N·m	0.16	0.51	1.02	1.45
	oz·in	22.5	72	144	205
Peak Torque ⁽⁴⁾	N·m	0.48	1.3	2.5	3.6
	oz·in	68	181	361	512
Rated Speed	rpm	3,000	4,000	4,000	4,000
Rated Power Output, Continuous	W	50	192	333	455
Electrical Specifications⁽²⁾					
BEMF Constant (Line-Line, Max)	$V_{pk}/krpm$	3.9	9	19	18
Continuous Current, Stall ⁽³⁾	A_{pk}	4.9	9.0	6.9	10.3
	A_{rms}	3.5	6.4	4.9	7.3
Peak Current, Stall ⁽⁴⁾	A_{pk}	14.7	22.5	17.3	25.8
	A_{rms}	10.4	15.9	12.2	18.2
Torque Constant ⁽⁵⁾	$N·m / A_{pk}$	0.032	0.06	0.15	0.14
	$oz·in / A_{pk}$	4.5	8.0	20.9	19.9
	$N·m / A_{rms}$	0.045	0.08	0.21	0.20
	$oz·in / A_{rms}$	6.4	11.4	29.6	28.1
Motor Constant ^(3,5)	$N·m / \sqrt{W}$	0.038	0.053	0.098	0.125
	$oz·in / \sqrt{W}$	5.37	7.52	13.84	17.77
Resistance, 25°C (Line-Line)	Ω	0.67	1.0	2.0	1.1
Inductance (Line-Line)	mH	0.73	1.42	3.52	2.18
Maximum Bus Voltage	VDC	80	340	340	340
Thermal Resistance	$^{\circ}C/W$	6.26	1.41	1.20	0.98
Number of Poles	-	8	8	8	8
Mechanical Specifications					
Frame Size	NEMA	17	23	23	23
Motor Weight	kg	0.4	1.1	1.5	2.0
	lb	0.88	2.42	3.30	4.40
Rotor Moment of Inertia	$kg·m^2$	2.00×10^{-6}	5.20×10^{-6}	9.20×10^{-6}	1.30×10^{-5}
	$oz·in·s^2$	0.00028	0.0007	0.0013	0.0018
Max. Radial Load	N	78	89	89	89
	lb	18	20	20	20
Max. Axial Load	N	39	89	89	89
	lb	9	20	20	20
Standards		2011/65/EU RoHS 2 Directive			

Notes:

- Performance is dependent upon heat sink configuration, system cooling conditions, and ambient temperature.
- All performance and electrical specifications $\pm 10\%$.
- Values shown @ 105°C rise above a 25°C ambient temperature, with motor mounted to a 250 mm x 250 mm x 6 mm aluminum heat sink.
- Peak torque assumes correct rms current; consult Aerotech.
- Torque constant and motor constant specified at stall.
- Maximum winding temperature is 130°C.
- Ambient operating temperature range 0°C - 25°C; consult Aerotech for performance in elevated ambient temperatures.
- All Aerotech amplifiers are rated A_{pk} ; use torque constant in $N·m/A_{pk}$ when sizing.

BM Series SPECIFICATIONS

Model		BM250	BM500
Performance Specifications^(1,2)			
Stall Torque, Continuous ⁽³⁾	N·m	2.3	3.6
	oz·in	322	515
Peak Torque ⁽⁴⁾	N·m	5.7	9.1
	oz·in	805	1,286
Rated Speed	rpm	4,000	4,000
Rated Power Output, Continuous	W	739	1065
Electrical Specifications⁽²⁾			
BEMF Constant (Line-Line, Max)	$V_{pk}/krpm$	28	29
Continuous Current, Stall ⁽³⁾	A_{pk}	10.3	17.5
	A_{rms}	7.2	12.4
Peak Current, Stall ⁽⁴⁾	A_{pk}	25.6	43.8
	A_{rms}	18.1	30.9
Torque Constant ⁽⁵⁾	$N·m / A_{pk}$	0.22	0.21
	$oz·in / A_{pk}$	31.4	29.4
	$N·m / A_{rms}$	0.31	0.29
	$oz·in / A_{rms}$	44.4	41.6
Motor Constant ^(3,5)	$N·m / \sqrt{W}$	0.198	0.275
	$oz·in / \sqrt{W}$	28.04	38.94
Resistance, 25°C (line to line)	Ω	1.1	0.5
Inductance (line to line)	mH	2.74	1.42
Maximum Bus Voltage	VDC	340	340
Thermal Resistance	$^{\circ}C/W$	0.99	0.74
Number of Poles	-	8	8
Mechanical Specifications			
Frame Size	NEMA	34	34
Motor Weight	kg	3.6	5.0
	lb	7.92	11.00
Rotor Moment of Inertia	$kg·m^2$	7.85×10^{-5}	1.39×10^{-4}
	$oz·in·s^2$	0.0111	0.0197
Max. Radial Load	N	178	178
	lb	40	40
Max. Axial Load	N	89	89
	lb	20	20
Standards		2011/65/EU RoHS 2 Directive	

Notes:

- Performance is dependent upon heat sink configuration, system cooling conditions, and ambient temperature.
- All performance and electrical specifications $\pm 10\%$.
- Values shown @ 105°C rise above a 25°C ambient temperature, with motor mounted to a 250 mm x 250 mm x 6 mm aluminum heat sink.
- Peak torque assumes correct rms current; consult Aerotech.
- Torque constant and motor constant specified at stall.
- Maximum winding temperature is 130°C.
- Ambient operating temperature range 0°C - 25°C; consult Aerotech for performance in elevated ambient temperatures.
- All Aerotech amplifiers are rated A_{pk} ; use torque constant in $N·m/A_{pk}$ when sizing.

BM Series SPECIFICATIONS

Model	BM800		
Performance Specifications^(1,2)			
Stall Torque, Continuous ⁽³⁾	N·m	6.1	11.0
	oz·in	866	1562
Peak Torque ⁽⁴⁾	N·m	15.3	27.6
	oz·in	2166	3905
Rated Speed	rpm	3,000	3,000
Rated Power Output, Continuous	W	1446	2529
Electrical Specifications⁽²⁾			
BEMF Constant (Line-Line, Max)	$V_{pk}/krpm$	69	69
Continuous Current, Stall ⁽³⁾	A_{pk}	11.9	20.5
	A_{rms}	8.4	14.5
Peak Current, Stall ⁽⁴⁾	A_{pk}	29.8	51.3
	A_{rms}	21.0	36.2
Torque Constant ⁽⁵⁾	$N·m / A_{pk}$	0.51	0.54
	$oz·in / A_{pk}$	72.8	76.2
	$N·m / A_{rms}$	0.73	0.76
	$oz·in / A_{rms}$	103	107.8
Motor Constant ^(3,5)	$N·m / \sqrt{W}$	0.439	0.713
	$oz·in / \sqrt{W}$	62.24	100.93
Resistance, 25°C (line to line)	Ω	1.2	0.5
Inductance (line to line)	mH	3.8	1.7
Maximum Bus Voltage	VDC	340	340
Thermal Resistance	$^{\circ}C/W$	0.67	0.54
Number of Poles	-	8	8
Mechanical Specifications			
Frame Size	NEMA	42	42
Motor Weight	kg	6.6	10.7
	lb	14.52	23.54
Rotor Moment of Inertia	$kg·m^2$	3.00×10^{-4}	5.60×10^{-4}
	$oz·in·s^2$	0.0425	0.0793
Max. Radial Load	N	222	222
	lb	50	50
Max. Axial Load	N	89	89
	lb	20	20
Standards	2011/65/EU RoHS 2 Directive		

Notes:

- Performance is dependent upon heat sink configuration, system cooling conditions, and ambient temperature.
- All performance and electrical specifications $\pm 10\%$.
- Values shown @ 105°C rise above a 25°C ambient temperature, with motor mounted to a 250 mm x 250 mm x 6 mm aluminum heat sink.
- Peak torque assumes correct rms current; consult Aerotech.
- Torque constant and motor constant specified at stall.
- Maximum winding temperature is 130°C.
- Ambient operating temperature range 0°C - 25°C; consult Aerotech for performance in elevated ambient temperatures.
- All Aerotech amplifiers are rated A_{pk} ; use torque constant in $N·m/A_{pk}$ when sizing.

BM Series SPECIFICATIONS

Model		BM2000	BM3400	BM4500
Performance Specifications^(1,2)				
Stall Torque, Continuous ⁽³⁾	N·m(lb·in)	14.7 (130)	23.7 (210)	31.6 (280)
Peak Torque ⁽⁴⁾	N·m(lb·in)	44.1 (390)	71.2 (630)	94.9 (840)
Rated Speed	rpm	2,400	2,400	2,400
Rated Power Output, Continuous	watts	3282	5073	6789
Electrical Specifications⁽²⁾				
BEMF Constant (line to line, max)	Volts _{pk} /krpm	99.0	99.0	113.1
Continuous Current, Stall ⁽³⁾	Amp _{pk}	16.5	26.7	31.1
	Amp _{rms}	11.7	18.9	22.0
Peak Current, Stall ⁽⁴⁾	Amp _{pk}	49.7	80.3	93.5
	Amp _{rms}	35.1	56.7	66.1
Torque Constant ⁽⁵⁾	N·m/Amp _{pk}	0.89	0.89	1.01
	lb·in/Amp _{pk}	7.9	7.9	9.0
	N·m/Amp _{rms}	1.25	1.25	1.43
	lb·in/Amp _{rms}	11.1	11.1	12.7
Motor Constant ^(3,5)	N·m/√W	1.13	1.86	2.31
	lb·in/√W	10.0	16.5	20.5
Resistance, 25°C (line-line)	ohms	0.54	0.20	0.17
Inductance (line-line)	mH	3.50	1.60	1.50
Maximum Bus Voltage	VDC	340	340	340
Thermal Resistance	C/W	0.78	0.80	0.69
Number of Poles	P	6	6	6
Encoder Options	Quadrature or Amplified Sine			
Mechanical Specifications				
Frame Size	NEMA	56	56	56
Motor Weight	kg (lb)	15 (33.0)	23 (49.9)	30 (66.9)
Rotor Moment of Inertia	kg·m ²	1.25x10 ⁻³	2.23x10 ⁻³	3.24x10 ⁻³
	lb·in·s ²	0.0111	0.0197	0.0287
Max. Radial Load	N (lb)	668 (150)	668 (150)	668 (150)
Max. Axial Load	N (lb)	223 (50)	223 (50)	223 (50)
Standards	2011/65/EU RoHS 2 Directive			

Notes:

- Performance is dependent upon heat sink configuration, system cooling conditions, and ambient temperature.
- All performance and electrical specifications ±10%.
- Values shown @ 130°C rise above a 25°C ambient temperature, with motor mounted to a 250 mm x 250 mm x 6 mm aluminum heat sink.
- Peak torque assumes correct rms current; consult Aerotech.
- Torque constant and motor constant specified at stall.
- Maximum winding temperature is 155°C.
- Ambient operating temperature range 0°C - 25°C; consult Aerotech for performance in elevated ambient temperatures.
- All Aerotech amplifiers are rated A_{pk}; use torque constant in N·m/A_{pk} when sizing.

BM Series MOTOR PERFORMANCE

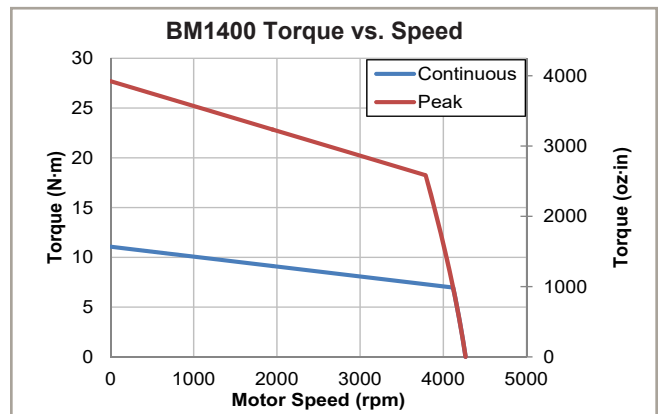
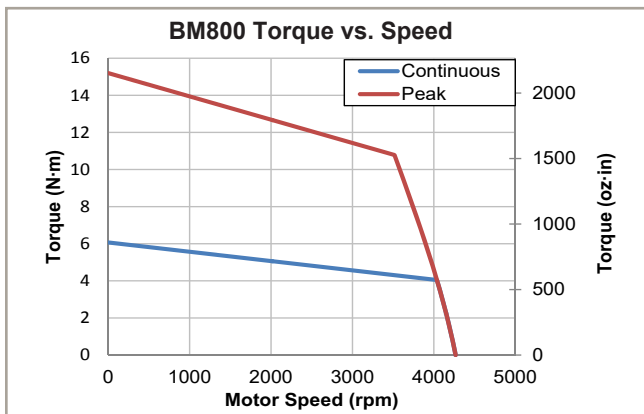
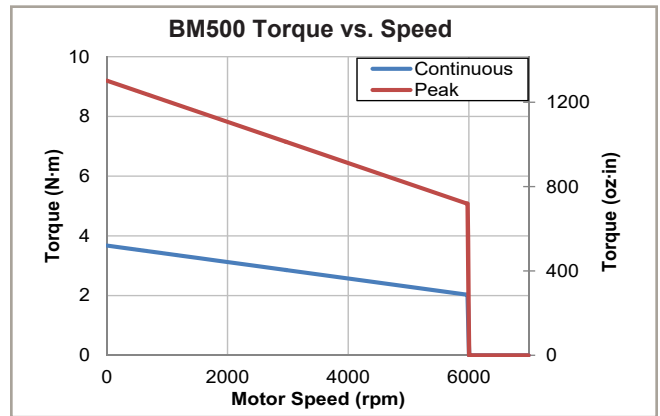
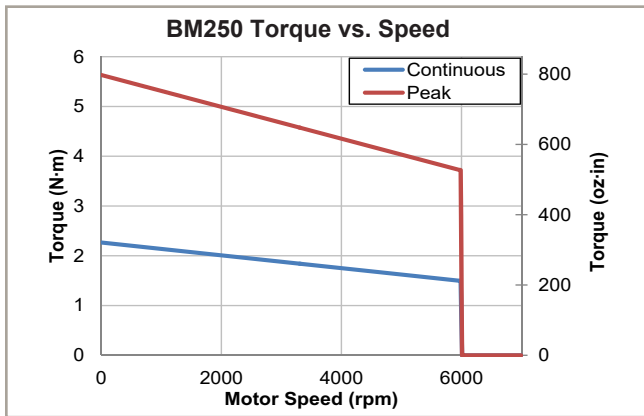
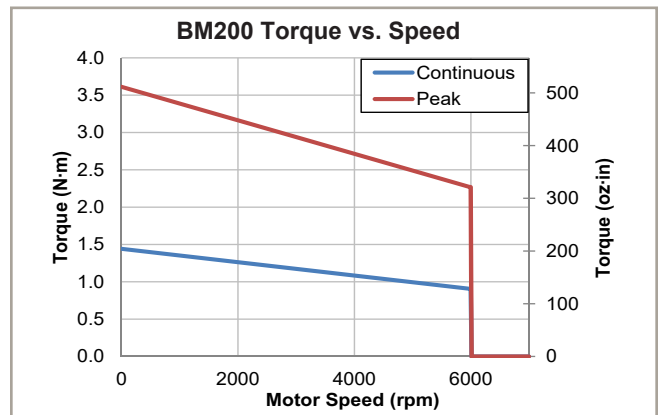
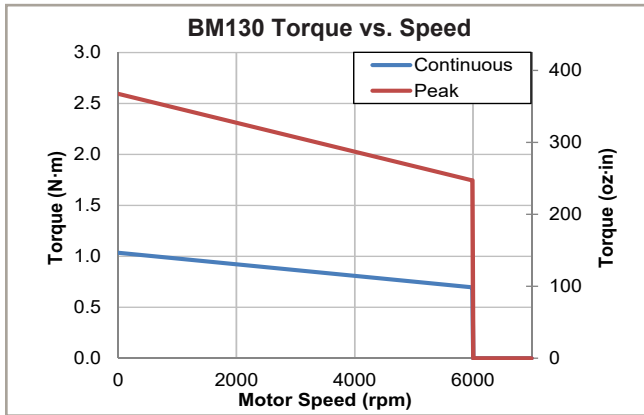
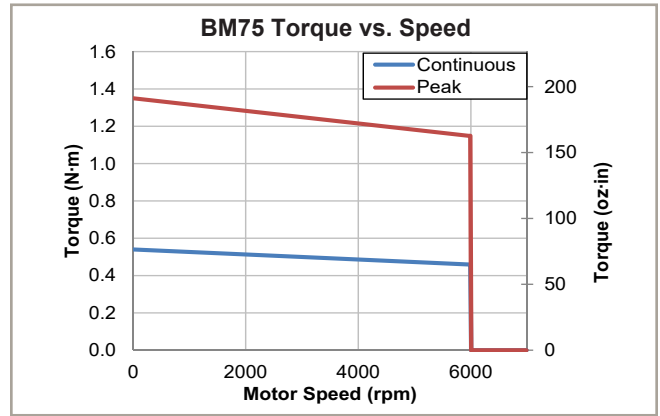
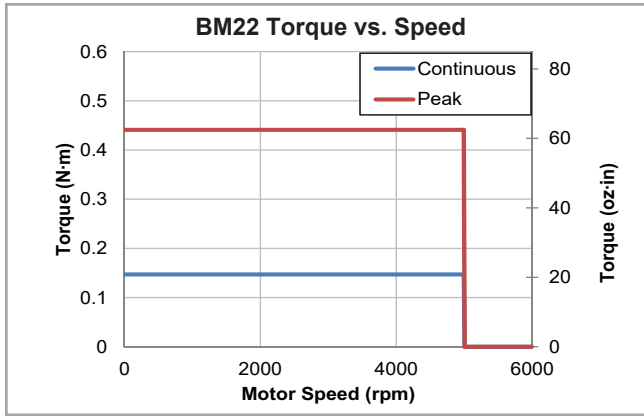

BM Series MOTOR PERFORMANCE

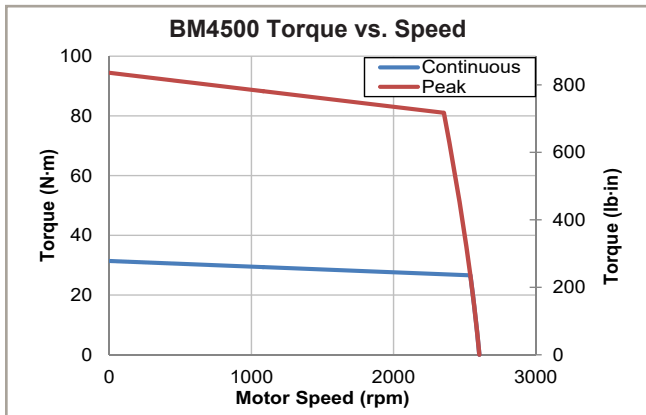
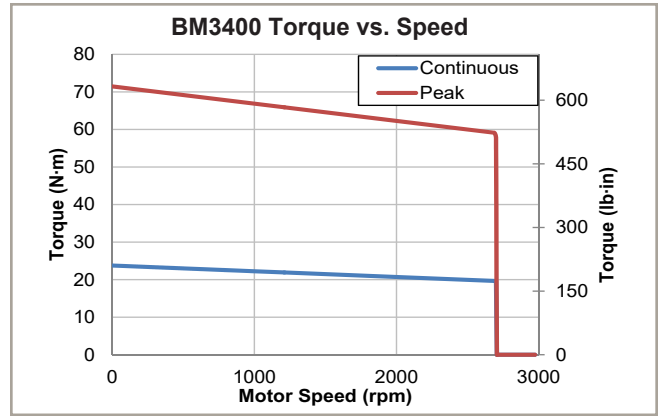
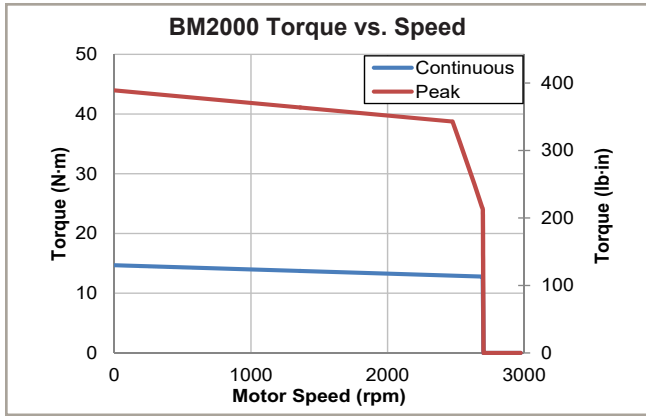

BM Series DIMENSIONS

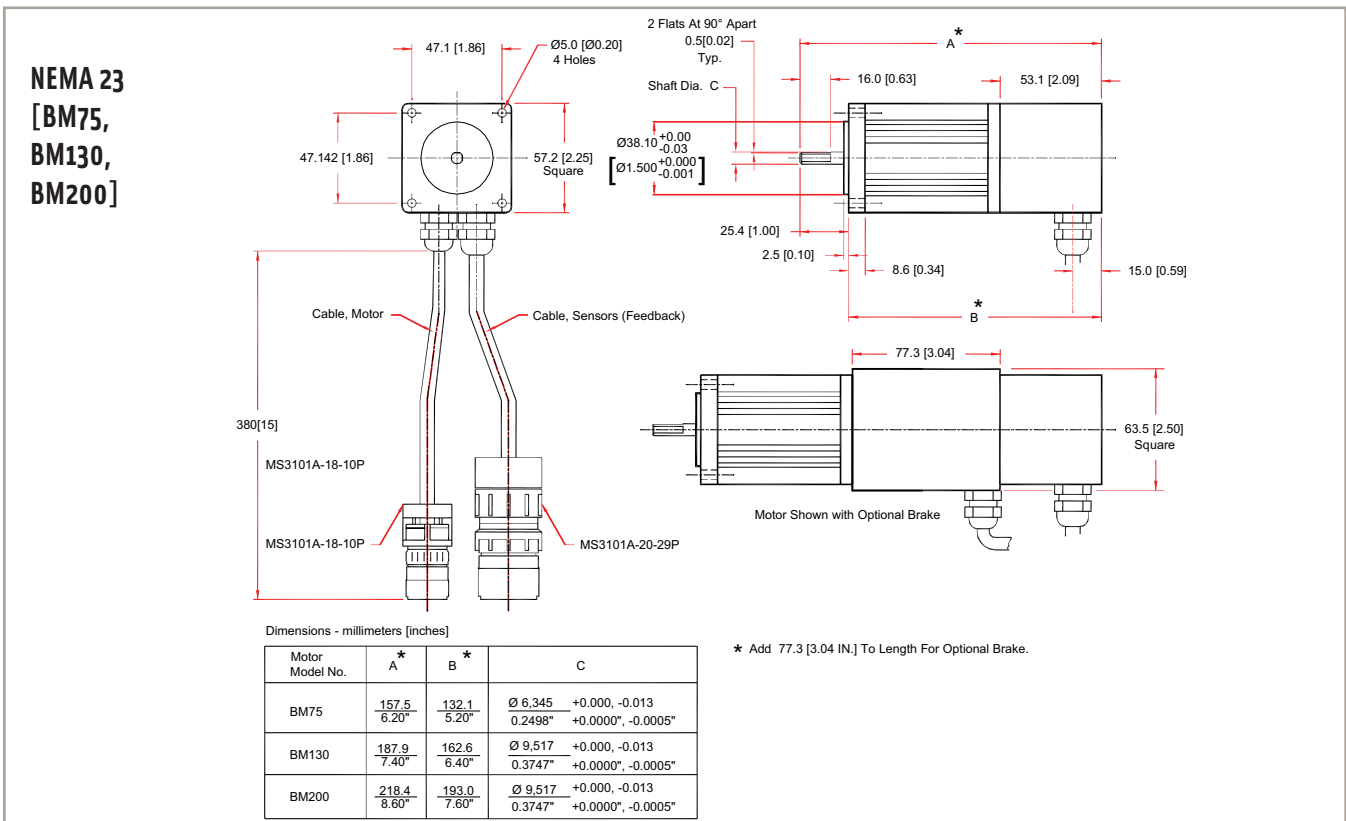
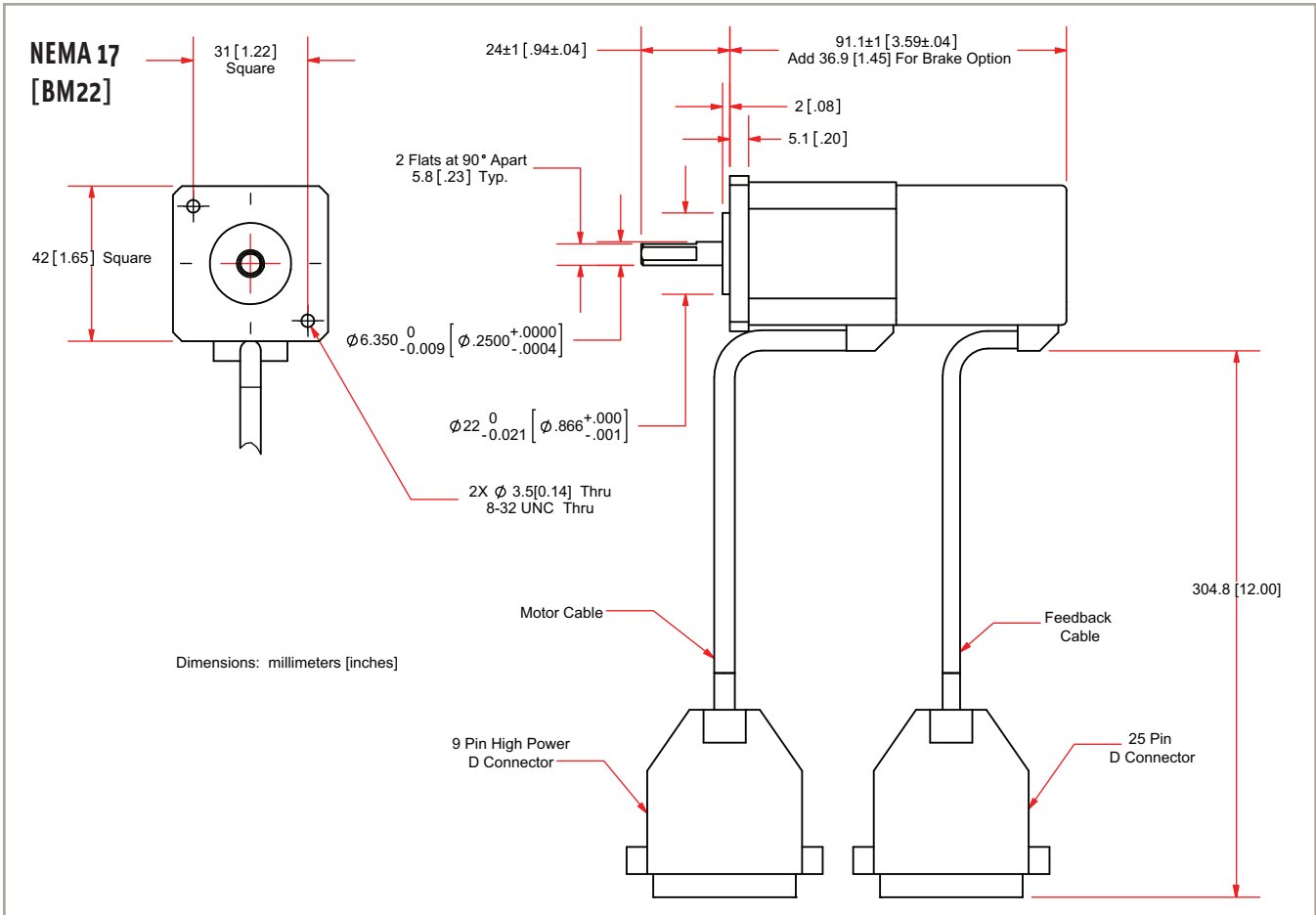

BM Series DIMENSIONS

NEMA 34 [BM250, BM500]

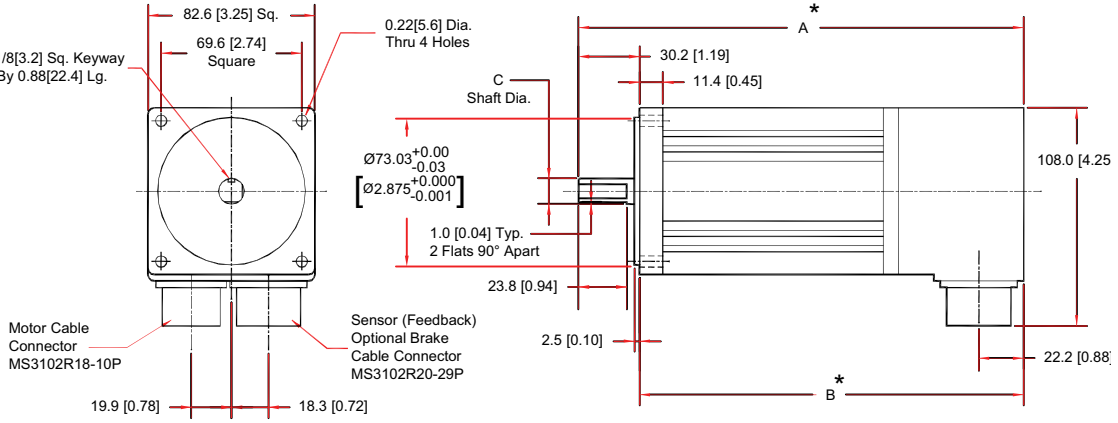

Dimensions - millimeters [inches]

Motor Model No.	A*	B*	C
BM250	220.3 8.67"	190.0 7.48"	∅ 12.69 +0.000, -0.013 0.4997" +0.0000", -0.0005"
BM500	275.1 10.83"	244.9 9.64"	∅ 12.69 +0.000, -0.013 0.4997" +0.0000", -0.0005"

* Add 55.6[2.19 IN.] To Length For Optional Brake.

NEMA 42 [BM800, BM1400]

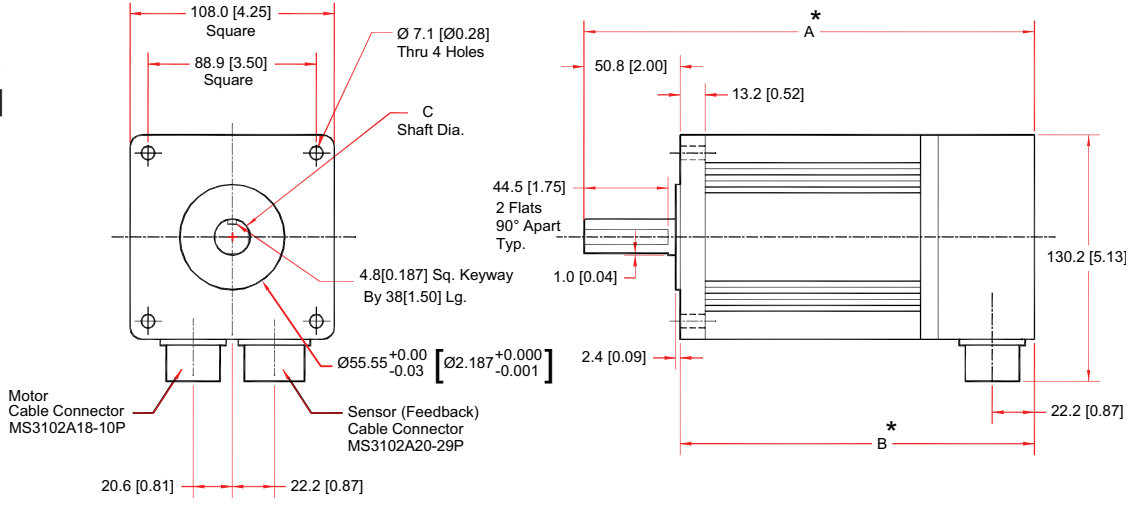

Dimensions - millimeters [inches]

Motor Model No.	A*	B*	C
BM800	238 9.37"	187 7.37"	∅ 19.04 +0.000, -0.013 0.7497" +0.0000", -0.0005"
BM1400	318 12.52"	267.2 10.52"	∅ 19.04 +0.000, -0.013 0.7497" +0.0000", -0.0005"

* Add 68.9[2.71 IN.] To Length For Optional Brake.

BM Series DIMENSIONS

NEMA 56
[BM2000,
BM3400,
BM4500]

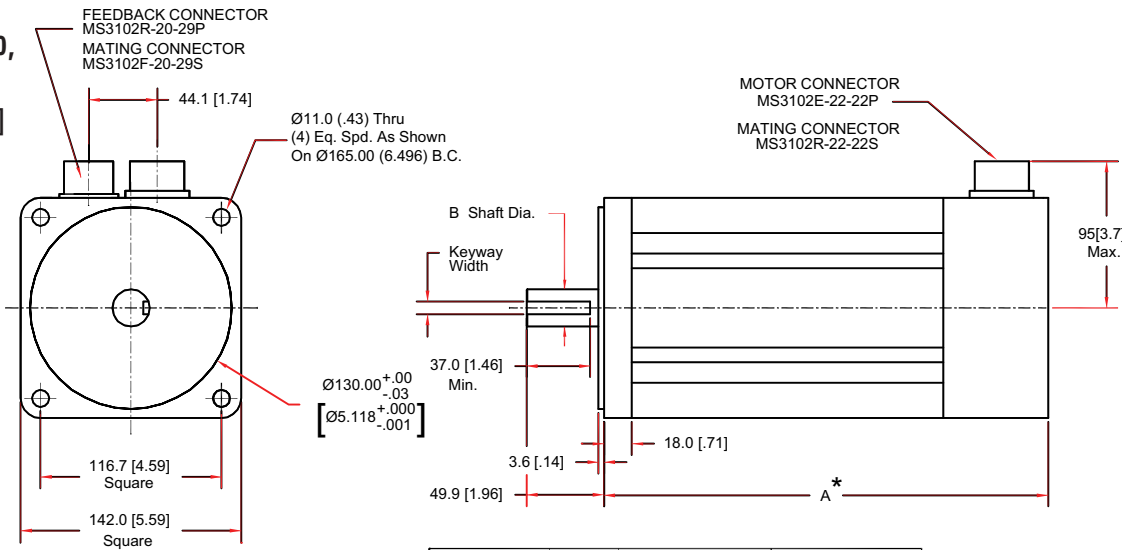

Dimensions - millimeters [inches]

Model No.	A*	B	Keyway
BM2000	286.8 11.29"	24.000 / 23.988 0.9449" / 0.9444"	7.998 / 7.963 0.3135" / 0.3149"
BM3400	355.3 13.99"	24.000 / 23.988 0.9449" / 0.9444"	7.998 / 7.963 0.3135" / 0.3149"
BM4500	423.9 16.69"	32.000 / 31.984 1.2598" / 1.2593"	9.975 / 10.000 0.3927" / 0.3937"

*Add 69[2.7] To Length For Optional Brake.

BM Series ORDERING INFORMATION

NEMA Brushless Rotary Servomotor

BM22	NEMA 17 brushless rotary servomotor
BM75	NEMA 23 brushless rotary servomotor
BM130	NEMA 23 brushless rotary servomotor
BM200	NEMA 23 brushless rotary servomotor
BM250	NEMA 34 brushless rotary servomotor
BM500	NEMA 34 brushless rotary servomotor
BM800	NEMA 42 brushless rotary servomotor
BM1400	NEMA 42 brushless rotary servomotor
BM2000	NEMA 56 brushless rotary servomotor
BM3400	NEMA 56 brushless rotary servomotor
BM4500	NEMA 56 brushless rotary servomotor

Connectors (Required)

-MS	Integral cable w/MS connector for Fbk and Mtr (-MS); not available for BM22
-D25	Integral cable w/D25 Fbk and 4D Mtr (-D25); only available on BM22, BM75, BM130, and BM200
-D25-9D	Integral cable w/D25 Fbk, 4D Mtr, and 9D Limit (-D25-9D); only available on BM75, BM130, and BM200
-D25-FLB	Integral cable w/D25 Fbk, Fly Leads for Mtr, and 9D Limit (-D25-FLB); only available on BM75, BM130, and BM200
-D25-5DU	Integral cable w/D25 Fbk, 5D Mtr, and 9D Limit (-D25-5DU); only available on BM75, BM130, and BM200
-D25-9D-CMS	Integral cable w/D25 Fbk, 4D Mtr, and 9D Limit - CMS Only (-D25-9D-CMS); only available on BM75, BM130, and BM200
-D25-4TS	Integral cable w/D25 Fbk, 4TS Mtr, and 9D Limit (-D25-4TS); only available on BM75, BM130, and BM200

Feedback (Required)

-E1000H	1000 lines/rev TTL incremental encoder w/Hall tracks (-E1000H); not available for BM22
-E2000H	2000 lines/rev TTL incremental encoder w/Hall tracks (-E2000H); not available for BM3400 or BM4500
-E2500H	2500 lines/rev TTL incremental encoder w/Hall tracks (-E2500H); not available for BM22
-E5000H	5000 lines/rev TTL incremental encoder w/Hall tracks (-E5000H); not available for BM22
-E1000ASH	1000 lines/rev 1 Vpp incremental encoder w/Hall tracks (-E1000ASH); not available for BM22, BM2000, BM3400 or BM4500

Brake (Optional)

-BK	Holding brake (-BK); not available on BM4500
-----	--

Cable Type (Optional)

-HF	High flex cable; only available on BM75, BM130, and BM200
-----	---

Cable Length (dm) (Optional)

-xx	Cable length in decimeters (3.8 dm is default); only available on BM75, BM130, and BM200
-----	--

Shaft Seal (Optional)

-NS	Nitrile front shaft seal; only available on BM250, BM500, BM800 and BM1400
-----	--

Vacuum Preparation (Optional)

-VAC6	Vacuum preparation to 10 ⁻⁶ Torr
-------	---

Accessories (Optional)

MC-HPD25-M	Connector; HPD motor power mate
MC-DB25-F	Connector; DB25 motor feedback mate
MCM1-3	Connector; MS motor power mate (BM2000, BM3400, BM4500)
MCM-3	Connector; MS motor power mate (BM75, BM130, BM200, BM250, BM500, BM800, BM1400)
MCF-3	Connector; MS motor feedback mate

Note: Accessories are ordered as separate line items.